

REV	REVISION	BY	ECN	DATE

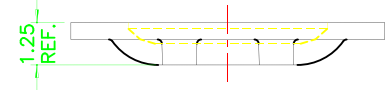

OPTIONAL MTG. PAN

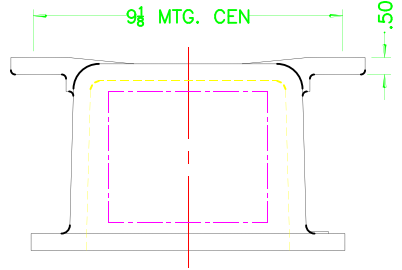
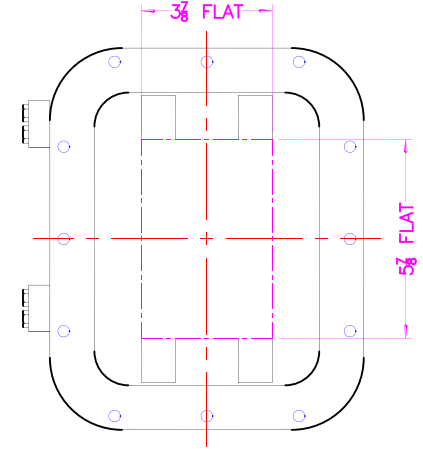
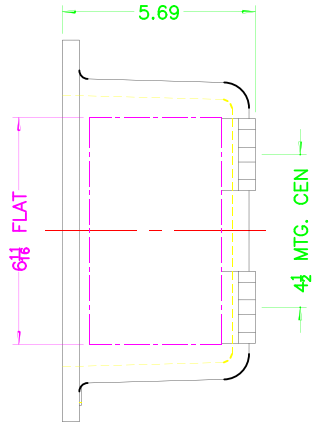
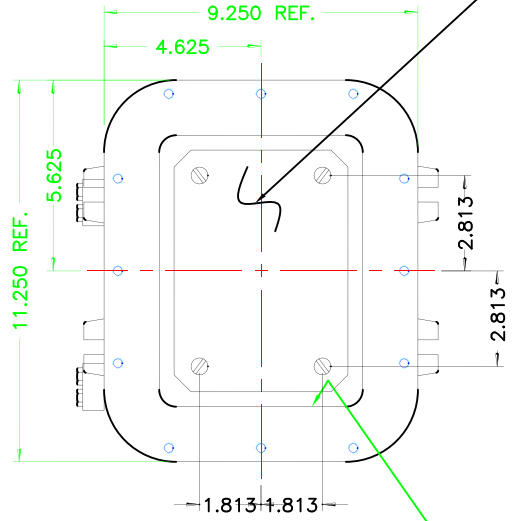

XCE 0608 COVER

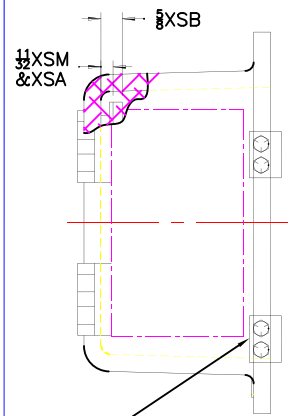

OPTIONAL XHB-2 HINGES

EXISTING GRD. SCREW

NOTES:

COVER DRILLING ALLOWABLE IN XCE ONLY

1. MINIMUM SPACING FROM CENTER OF OPERATOR TO NEAREST FLAT IS 1 1/8.
2. MINIMUM SPACING BETWEEN 3/4-14 NPSM OPERATOR CENTERS IS 2 1/2 FOR THIS ENCLOSURE.
3. MAXIMUM NUMBER OF OPERATORS IS 2.
4. DIMENSION FROM CENTER LINES OF COVER FOR OPERATORS.
5. DIMENSION FROM CENTER LINE AND BACK OF MTG. LUG FOR CONDUIT.
6. FOR MTG. ENCLOSURE USE 3/8 BOLT.

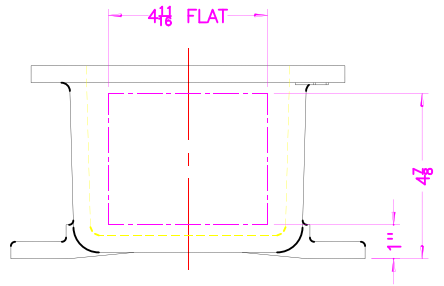

DO NOT SCALE DRAWING UNLESS OTHERWISE SPECIFIED DIMENSIONS ARE IN INCHES. CAST TOLERANCES ON DIMENSIONS NOT OTHERWISE SPECIFIED: √ = 1/8" STOCK FILLET OR CORNER RADI 1/8" DRAFT 1 1/2" FRAC ± 1/16" ANGLES ± 1° MACHINE TOLERANCES ON DIMENSIONS NOT OTHERWISE SPECIFIED: √ = 125 FIL ± .03" EDGE BREAK .005"-.015" R. or 45° ANGLES ± 0°-30° GAGING FOR THREADED HOLES NOT OTHERWISE SPECIFIED: NPT E-21-2.6 NPSM E-24-1.0		ADALET A SCOTT FETZER COMPANY Enclosure Systems -Cable Accessories		TITLE MODIFIED XCE/XJF 060805 ENCLOSURE FOR	
NOTICE TO PERSONS RECEIVING THIS DRAWING: ADALET-PLM CLAIMS PROPRIETARY RIGHTS IN THE MATERIAL DISCLOSED HEREON. THIS DRAWING IS ISSUED IN CONFIDENCE FOR ENGINEERING INFORMATION ONLY AND MAY NOT BE REPRODUCED OR USED TO MANUFACTURE ANYTHING SHOWN HEREON WITHOUT DIRECT WRITTEN PERMISSION FROM ADALET-PLM TO THE USER.		DRAWN BY	DDH	DATE	4-20-01
FINISH TUMBLAST		ENG APPROVAL		PLOT SCALE	1=3
CAT NO XCE/XJF 060805		MFG APPROVAL		DWG SIZE	C
			DWG NO	SHT	REV
				10F1	